

## Agenda 9<sup>th</sup> User Group meeting in Brussels\*

21/11/2018 12:30 – 16:00 CET

TIME	AGENDA ITEM	PRESENTER
12:30 – 13:15	<b>Lunch</b>	
13:15 – 13:25	<b>1. Welcome, agenda</b>	Mark Pickles
13:25 – 13:50	<b>2. Feedback Market Parties on XBID operation</b>	Mark Pickles (moderation)
13:50 – 14:20	<b>3. Improvements of XBID Solution</b> a) Tick-size analysis outcome b) Order book depth	Katharina Niciejewska, EPEX Karol Nicia, EMCO
14:20 – 15:05	<b>4. Regulatory changes and foreseen impact on XBID</b> a) Information about the implementation of the final model (model B) in Iberian market b) Timing Gate Opening Time (GOT) as of 2019 c) Concept for implementation of losses	Nuria Tranco, OMIE (Iberian market representative) Bruno Lemetayer, RTE Chris Kleinpenning, TTN & Timo Suhonen, EMCO
15:05 – 15:20	<b>Coffee break</b>	
15:20 – 15:35	<b>5. Project status update</b>	Mark Pickles
15:35 – 15:50	<b>6. 2<sup>nd</sup> wave LIPs and high level planning</b>	Zuzana Vackova, OTE
15:50 – 16:00	<b>7. Wrap up</b>	Mark Pickles

\* Exact address: Radisson Blu Royal Hotel, Rue du Fossé-aux-Loups 47, 1000 Brussels

## **Agenda**

**13:25 – 13:50**

- 1. Welcome, agenda**
- 2. Feedback Market Parties on XBID operation – Mark Pickles**
- 3. Improvements of XBID Solution**
- 4. Regulatory changes and foreseen impact on XBID**
- 5. Project status update**
- 6. 2<sup>nd</sup> wave LIPs and high level planning**
- 7. Wrap up**

## **2. Feedback Market Parties on XBID operation**

### **General Overview**

- XBID went live on 12<sup>th</sup> June with first deliveries on 13<sup>th</sup> June
- The project parties consider Go-live as a significant success with all 1<sup>st</sup> go-live parties/ Local Implementation Projects (LIPs) able to operate as planned
- XBID has been stable since go-live
- Average trading volumes show growth from Go-Live to a new high of 1.4 million trades in the month of October 2018
- Some minor incidents have occurred (as expected) but these have been managed/ resolved without significant impacts in the market
- Project Parties are focussing on 2<sup>nd</sup> wave go-live (planned for summer 2019) and the future development of the XBID solution.
- Analysis is also underway on performance improvements which are expected to result in developments to build on the successful 1<sup>st</sup> go-live
- OPSCOM – the body that monitors operational activities - is fully established. A fundamental revision of the current organisational structure was implemented in September 2018 to reflect the move from project to operational/development status
- IDSC recognised that XBID is running with stability and therefore, in line with IDOA, the rollback systems were not kept available after XBID had been running for more than 2 months (communicated by a press release on 6<sup>th</sup> September)

## 2. Feedback Market Parties on XBID operation Development orders and trades since XBID go-live

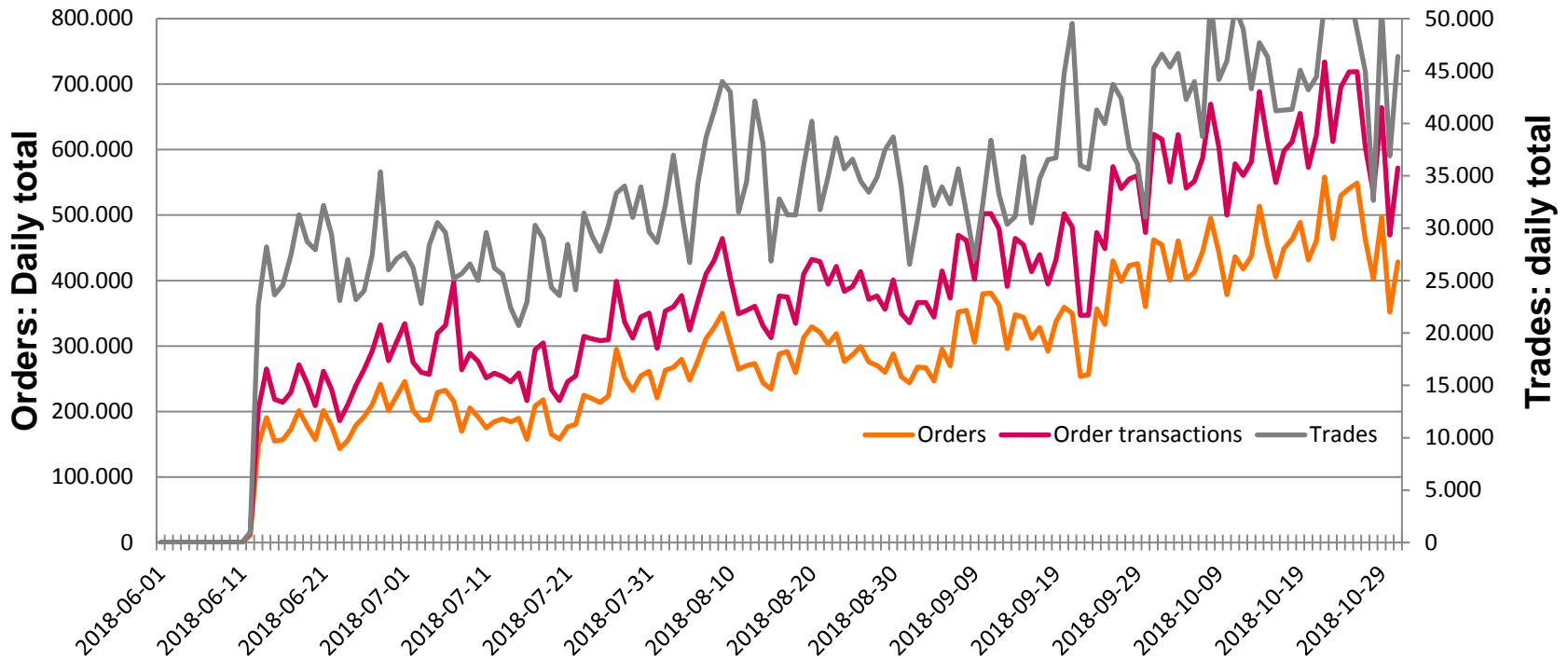

Term	Description	Definitions and computation details
<b>Orders</b>	<b>Total daily</b> number of Orders (incl. Block Orders) and total daily number of Order Transactions (including Block Order Transactions) per given day.	<ul style="list-style-type: none"> <li>Order is defined as order entry.</li> <li>Order Transaction - means the Order entry (including activation of new iceberg slice), Order modification (including Order activation and deactivation) and Order deletion (excluding Order deletions due to contract expiration); partial matches as well as full Order executions are not to be considered as Order Transaction. Events triggered by or during MA/DA halt, Market Halt, Suspend user, activation of dispute state are not counted as Order Transaction;</li> </ul>
<b>Trades</b>	<b>Total daily</b> number of Trades (incl. Block Trades) per given day as well as hourly number per given hour.	Daily Trades - means the Transactions concluded after the matching of two (2) Orders within one (1) Trading Day;

## 2. Feedback Market Parties on XBID operation

### Development block orders and trades since XBID go-live

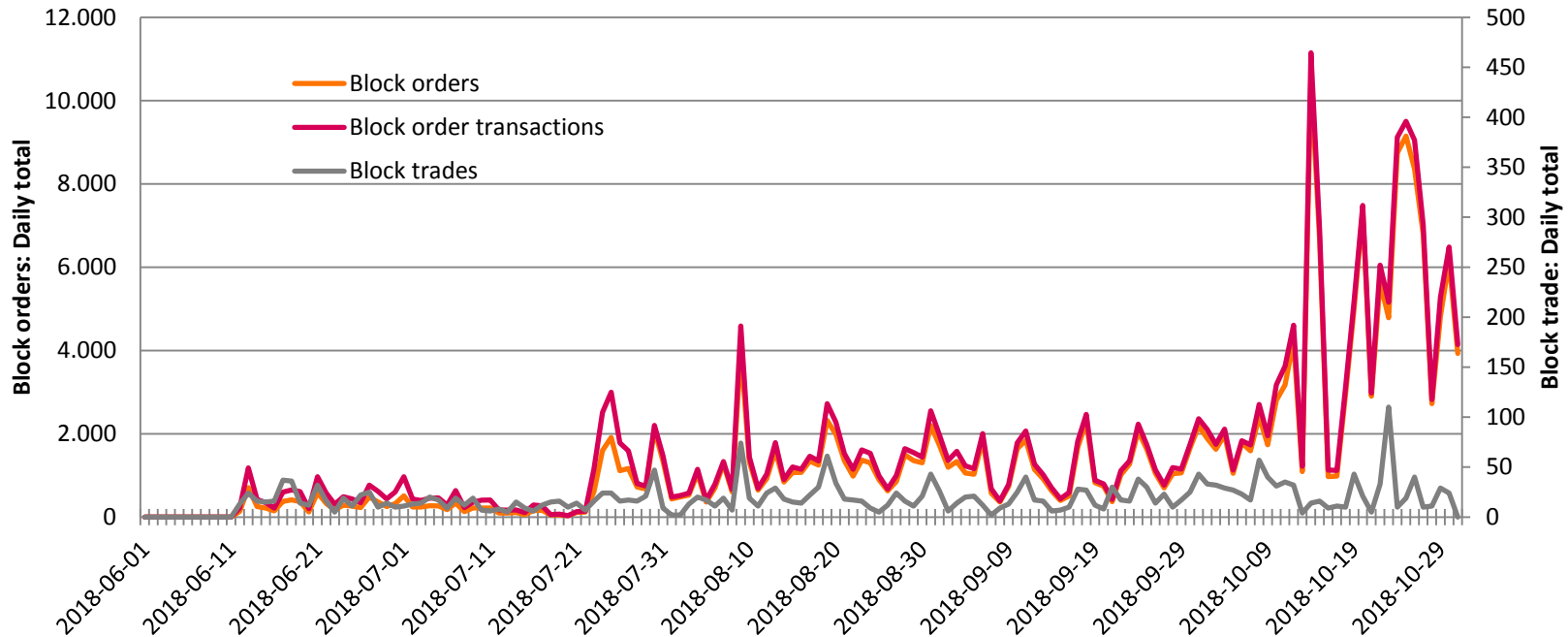

Term	Description	Definitions and computation details
<b>Block orders</b>	<b>Total daily</b> number of Block orders and total daily number of Block Order Transactions per given day.	<ul style="list-style-type: none"> <li>Block Order is defined as order entry placed on the Block Contract.</li> <li>Block Order Transaction means order entry, order modification (including order activation and deactivation) and order deletion (excluding order deletions due to contract expiration) for a Block Contract. Full and partial executions are not considered as Block Order Transaction; Events triggered or during MA/DA halt, Market Halt, Suspend user, activation of dispute state are not considered as Block Order Transaction;</li> </ul>
<b>Block trades</b>	<b>Total daily</b> number of Block Trades per given day as well as hourly number per given hour.	Daily Block Trades means the Transactions concluded after the matching of two (2) Block Orders within one (1) Trading Day;

## 2. Feedback Market Parties on XBID operation

### Development of explicit allocations since XBID go-live

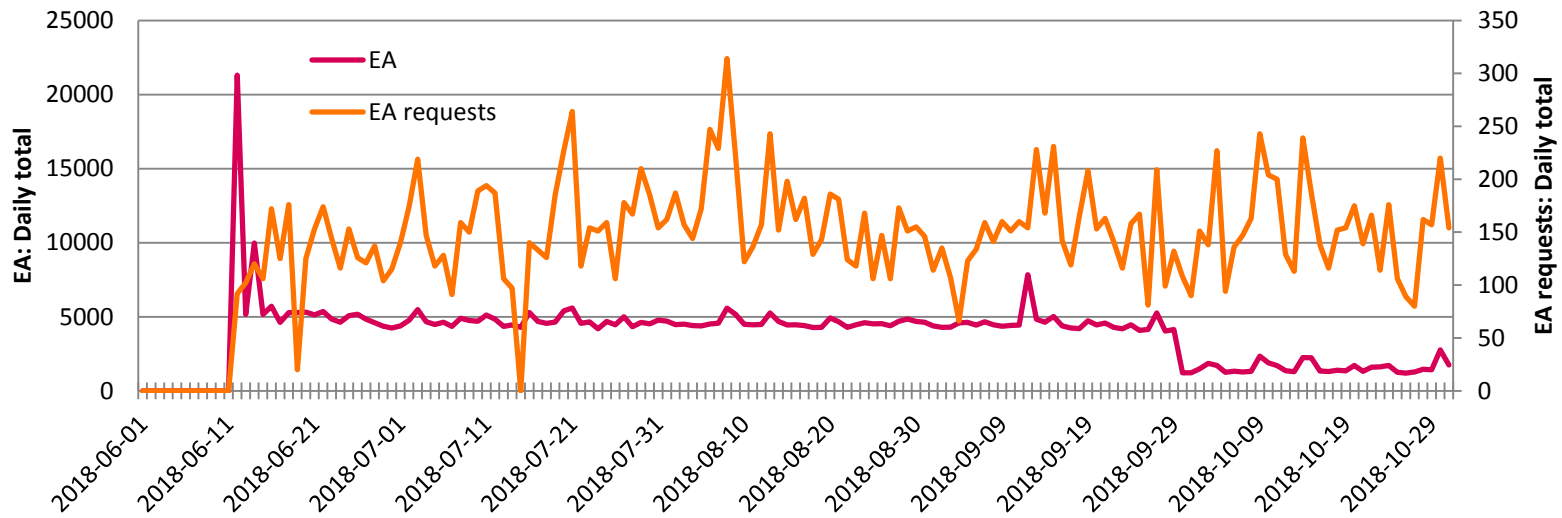

Term	Description	Definitions and computation details
<b>Explicit capacity allocation requests (EARs)</b>	<b>Total daily</b> number of Explicit capacity allocation requests per given day as well as hourly number per given hour.	<p>EARs are basically any requests which are non-implicit, i.e. not coming from the SOB:</p> <ul style="list-style-type: none"> <li>Allocation request made by an Explicit Participant (or TSO Admin acting on its behalf) via the GUI (entering the values in the fields)</li> <li>Special kind of such allocation requests are Balancing Mechanism and GenOutage                             <ul style="list-style-type: none"> <li>Allocation request made by an Explicit Participant (or TSO Admin acting on its behalf) via the GUI by uploading an allocation request file (BG request file or BID file)</li> </ul> </li> <li>Special kind of such allocation requests are Balancing Mechanism and GenOutage                             <ul style="list-style-type: none"> <li>Allocation request made by an Explicit Participant (or TSO Admin acting on its behalf) via API – AllocationReq</li> <li>Submitting a valid CAS/CBS file (via a communication channel) which adheres to an existing file transfer configuration</li> </ul> </li> </ul>
<b>Explicit capacity allocation</b>	<b>Total daily</b> number of Explicit capacity allocation requests per given day as well as hourly number per given hour.	Explicit Allocations (EAs) are EARs which are granted, i.e. successfully carried out. Allocations from CAS/CBS files are specific kind of allocations counted as EAs.

## Agenda

**13:50 – 14:05**

- 1. Welcome, agenda**
- 2. Feedback Market Parties on XBID operation**
- 3. Improvements of XBID Solution**
  - a) Tick-size analysis outcome - Katharina Niciejewska
  - b) Order book depth – Karol Nicia
- 4. Regulatory changes and foreseen impact on XBID**
- 5. Project status update**
- 6. 2<sup>nd</sup> wave LIPs and high level planning**
- 7. Wrap up**

### 3.a) Tick-size analysis outcome

#### Tick size of submitted orders – history/description

- Background:
  - Following Member Associations letter received in H1 2018 by XBID project, the Commission took following decision during a meeting in April 2018: ***“XBID will undertake an interim assessment by mid-August to see if there are any significant detrimental impacts of the tick size on the single intraday market. In this case, the concerned NEMOs will take the necessary operational measures to mitigate those negative impacts”***.
  - As a consequence, project parties were assigned AP to analyze impact of the price tick on the operation of XBID and share the results of the elaboration with the market parties
  - NEMOs performed an analysis based on first month of operations
    - The analysis executed on the data for the 1st operational month shows that **majority of the monitored parameters are within the agreed systems boundaries** though some measured parameters were breached and are subject of further analysis (e.g. Order transaction peak load)
    - **None of the breaches identified during analysis indicated an immediate need for proposing to change the tick size**



### **3.a) Tick-size analysis outcome**

#### **Tick size of submitted orders – next steps**

- As highlighted previously the XBID platform proved to run very smoothly over the last months. At the same time the averaged daily number of submitted orders has been increased by a factor  $> 2$  between June and September 2018. Some of the contractual boundaries are breached.
- NEMOS and TSOs are still investing massively to guarantee good level of performance.
- Please note that there is an ongoing activity under the umbrella of ACER which focuses on the harmonization of various market parameters. Tick size is one of the parameters which may be considered as a part of this process.

## Agenda

14:05 – 14:20

1. Welcome, agenda
2. Feedback Market Parties on XBID operation
3. **Improvements of XBID Solution**
  - a) Tick-size analysis outcome - Katharina Niciejewska
  - b) Order book depth – Karol Nicia
4. Regulatory changes and foreseen impact on XBID
5. Project status update
6. 2<sup>nd</sup> wave LIPs and high level planning
7. Wrap up

### 3.b) Order book depth limitations relaxation – history/description

- Before the XBID BGL 30<sup>th</sup> May DBAG was requested to analyse possible removal of orderbook depth (OBD) visibility limitations
- Supplier results from performed analysis on orderbook depth and SLAs validity, connected to extra hardware purchase for these tests, pointed out that the full removal is not possible, however considerable ‘relaxation’ can be done
- Possible implementation of order book depth limitation relaxation would be connected to additional investment
- Summary table:

Products	Current order book depth limitations	Proposed relaxation of order book depth limitations*
All products but blocks	Max OBD 31 if $\geq$ sum of 600 MW	Max OBD up to 100 orders
All products but blocks	Max OBD up to 50 orders, $\leq$ sum of 600 MW	
Block products	Max OBD up to 2 block orders	Max OBD / contract length rounded down (reflecting limit of 100), Examples: <ul style="list-style-type: none"> <li>• 2-hour block =&gt;Max OBD is 50 orders</li> <li>• 10-hour block =&gt;Max OBD is 10 orders</li> <li>• 24-hour block =&gt;Max OBD is 4 orders</li> </ul>

\* Parameters specified in the Proposed relaxation of order book depth limitations are subject of the implementation and XBID performance retest.

### **3.b) Order book depth limitations relaxation Feedback from Market Participants**

XBID project parties would appreciate feedback from Market participants if the results from analysis on order book depth relaxation meet Market participants expectations.

## Agenda

14:20 – 14:25

1. **Welcome, agenda**
2. **Feedback Market Parties on XBID operation**
3. **Improvements of XBID Solution**
4. **Regulatory changes and foreseen impact on XBID**
  - a) Information about the implementation of the final model (model B) in Iberian market – Nuria Trancho
  - b) Timing Gate Opening Time (GOT) as of 2019 – Bruno Lemetayer
  - c) Concept for implementation of losses - Chris Kleinpenning & Timo Suhonen
5. **Project status update**
6. **2<sup>nd</sup> wave LIPs and high level planning**
7. **Wrap up**

## 4.a) Information requested in the previous UG about the implementation of the Enduring Iberian Hybrid Model

1. Iberian NRA's requested from:
  - REE and REN as Iberian System Operators,
  - OMIE as Iberian Market Operator,the updating of the current Iberian Hybrid Model, defined in the Iberian Market Rules approved in May 2018, from the initial interim solution (implemented at the date of the XBID Go-live), to an enduring and final solution before the end of November, 2018.
2. REE, REN and OMIE have been working in the implementation of this enduring hybrid model.
3. OMIE has imparted three webinar sessions, in order to keep Market Participants informed and updated about the new features and characteristics of the model.
4. During the first three weeks of November (starting on November the 7<sup>th</sup> till November the 23<sup>rd</sup>) it is possible for the Iberian Market Participants to join the testing phase and experience the upcoming model.
5. The Go-live date of the new and enduring Iberian Model will take place **next 27<sup>th</sup> of November** (as it is stipulated in the current Iberian Market Rules).

## Agenda

14:25 – 14:35

1. Welcome, agenda
2. Feedback Market Parties on XBID operation
3. Improvements of XBID Solution
4. Regulatory changes and foreseen impact on XBID
  - a) Information about the implementation of the final model (model B) in Iberian market – Nuria Trancho
  - b) Timing Gate Opening Time (GOT) as of 2019 – Bruno Lemetayer
  - c) Concept for implementation of losses - Chris Kleinpenning & Timo Suhonen
5. Project status update
6. 2<sup>nd</sup> wave LIPs and high level planning
7. Wrap up

## 4.b) Timing Gate Opening Time (GOT) as of 2019

### A. Background

- ACER's decision of April 2018 defines IDCZGOT as 15:00 D-1 from 01.01.2019 onwards
  - Deadline postponed until 30 days after approval of intraday capacity calculation methodology for CCRs where such approval isn't made before 30.11.2018
- Effective implementation is managed on each relevant border
- XBID project is providing MPs with a detailed overview on GOT timings for borders in operation
  - *Effective GOT* in place as of 01.01.2019 and application of ACER's decision
  - Corresponding capacity available, especially for borders where no cross-border capacity can be published at *Effective GOT*



## 4.b) Timing Gate Opening Time (GOT) as of 2019

### B. Details / Baltic CCR

- Baltic CCR's intraday capacity calculation methodology has been approved

Bidding zone border	<i>Effective GOT</i> as of 01.01.2019	Cross-border capacities published at <i>Effective GOT</i>	Point in time cross-border capacity is made available after <i>Effective GOT</i>
EE-FI	15:00, D-1 CET	Calculated cross-border capacity	N/A
EE-LV	15:00, D-1 CET	Calculated cross-border capacity	N/A
LT-SE4	15:00, D-1 CET	0	As soon as possible after <i>Effective GOT</i>
LV-LT	15:00, D-1 CET	Calculated cross-border capacity	N/A

## 4.b) Timing Gate Opening Time (GOT) as of 2019

### B. Details / Core CCR

- Core CCR's intraday capacity calculation methodology is currently under approval (ACER decision not expected before mid-February 2019)

Bidding zone border	<i>Effective GOT</i> as of 01.01.2019	Cross-border capacities published at <i>Effective GOT</i>	Point in time cross-border capacity is made available after <i>Effective GOT</i>
DE-NL	15:00 CET, D-1 (*)	0	22:00 CET, D-1 (**)
FR-BE	15:00 CET, D-1 (*)	0	22:00 CET, D-1 (**)
BE-NL	15:00 CET, D-1 (*)	0	22:00 CET, D-1 (**)
DE-FR	15:00 CET, D-1 (*)	0	22:00 CET, D-1 (**)
DE-AT	15:00 CET, D-1 (*)	0	22:00 CET, D-1 (**)
Notes	(*) Implementation date will be 30 days after NRAs' approval (**) At the latest		

## 4.b) Timing Gate Opening Time (GOT) as of 2019

### B. Details / Hansa CCR

- Hansa CCR's intraday capacity calculation methodology is currently under approval (NRAs' decision not expected before mid-December 2018)

Bidding zone border	Effective GOT as of 01.01.2019	Cross-border capacities published at Effective GOT	Point in time cross-border capacity is made available after Effective GOT
DE-DK1	15:00, D-1 CET (*)	0	18:00 CET (**)
DE-DK2	15:00, D-1 CET (*)	0	18:00 CET (**)
NO2-NL	15:00, D-1 CET	0	18:00 CET (***)
Notes	(*) Implementation date will be 30 days after NRAs' approval (**) Approximate timing (***) At the latest		

## 4.b) Timing Gate Opening Time (GOT) as of 2019

### B. Details / Nordic CCR

- Nordic CCR's intraday capacity calculation methodology has been approved

Bidding zone border	<i>Effective GOT</i> as of 01.01.2019	Cross-border capacities published at <i>Effective GOT</i>	Point in time cross- border capacity is made available after <i>Effective GOT</i>
DK1-DK2, DK1-NO2, DK1-SE3, DK2-SE4	15:00, D-1 CET (*)	Calculated cross-border capacity	N/A
FI-SE1, FI-SE3	15:00, D-1 CET	Calculated cross-border capacity	N/A
NO1-NO2, NO1-NO3, NO1-NO5, NO1-SE3, NO2-NO5, NO3-NO5, NO3-SE2, NO4-SE1, NO3-SE4, NO4SE2, SE1-SE2, SE2-SE3, SE3-SE4	15:00, D-1 CET	Calculated cross-border capacity	N/A
NO3-NO4	15:00, D-1 CET	0	18:00 CET (**)
Notes	(*) Already in place today (**) At the latest		

## 4.b) Timing Gate Opening Time (GOT) as of 2019

### B. Details / SWE CCR

- SWE CCR's intraday capacity calculation methodology has been approved

Bidding zone border	<i>Effective GOT</i> as of 01.01.2019	Cross-border capacities published at <i>Effective GOT</i>	Point in time cross-border capacity is made available after <i>Effective GOT</i>
FR-ES	15:00, D-1 CET (*)	<i>Under NRAs' assessment</i>	<i>Under NRAs' assessment</i>
ES-PT	15:00, D-1 CET (*)	Calculated cross-border capacity	N/A
Notes	(*) Implementation date under NRAs' assessment		

## Agenda

14:35 – 15:05

1. Welcome, agenda
2. Feedback Market Parties on XBID operation
3. Improvements of XBID Solution
4. Regulatory changes and foreseen impact on XBID
  - a) Information about the implementation of the final model (model B) in Iberian market – Nuria Trancho
  - b) Timing Gate Opening Time (GOT) as of 2019 – Bruno Lemetayer
  - c) Concept for implementation of losses - Chris Kleinpenning & Timo Suhonen
5. Project status update
6. 2<sup>nd</sup> wave LIPs and high level planning
7. Wrap up

## **Agenda**

**14:35-15:05**

### **I. Introduction**

**II. Losses on HVDC interconnectors**

**III. Implicit losses in DA Market Coupling**

**IV. Implicit losses in XBID**

**V. BACK-UP: NRAs questions and NEMOs/TSOs answers**

# I. Introduction

- In 2012-13 a consultancy study was carried out to analyse the effects of implement losses for the DA timeframe. The conclusion was a net welfare gain by implement loss factors on DC interconnectors
- NWE price coupling started in Feb 2014
- NRAs raised several questions to TSOs. One of these was related to only have losses in DA and not in ID trade.
- The reply from TSOs and NEMOs was:
  - *"As a conclusion: in the worst case a positive day ahead welfare effect from inclusion of a loss factor can be reduced by intraday trade if the intraday trading mechanism does not take the loss factor into account but it cannot lead to a negative net welfare effect over both markets. For the worst case to occur the DC interconnector which was not used to "carry" DA flow, must be completely utilized for ID trade."*
- By introducing losses in ID the risk of losing the benefit from having losses in DA allocation disappears



## **Agenda**

**14:35-15:05**

**I. Introduction**

**II. Losses on HVDC-interconnectors**

**III. Implicit losses in DA Market Coupling**

**IV. Implicit losses in XBID**

**V. BACK-UP: NRAs questions and NEMOs/TSOs answers**

## II. Losses on HVDC-interconnectors (1)

- Actual losses are a combination of converter losses (transport independent losses) and cable losses (transport dependent losses).

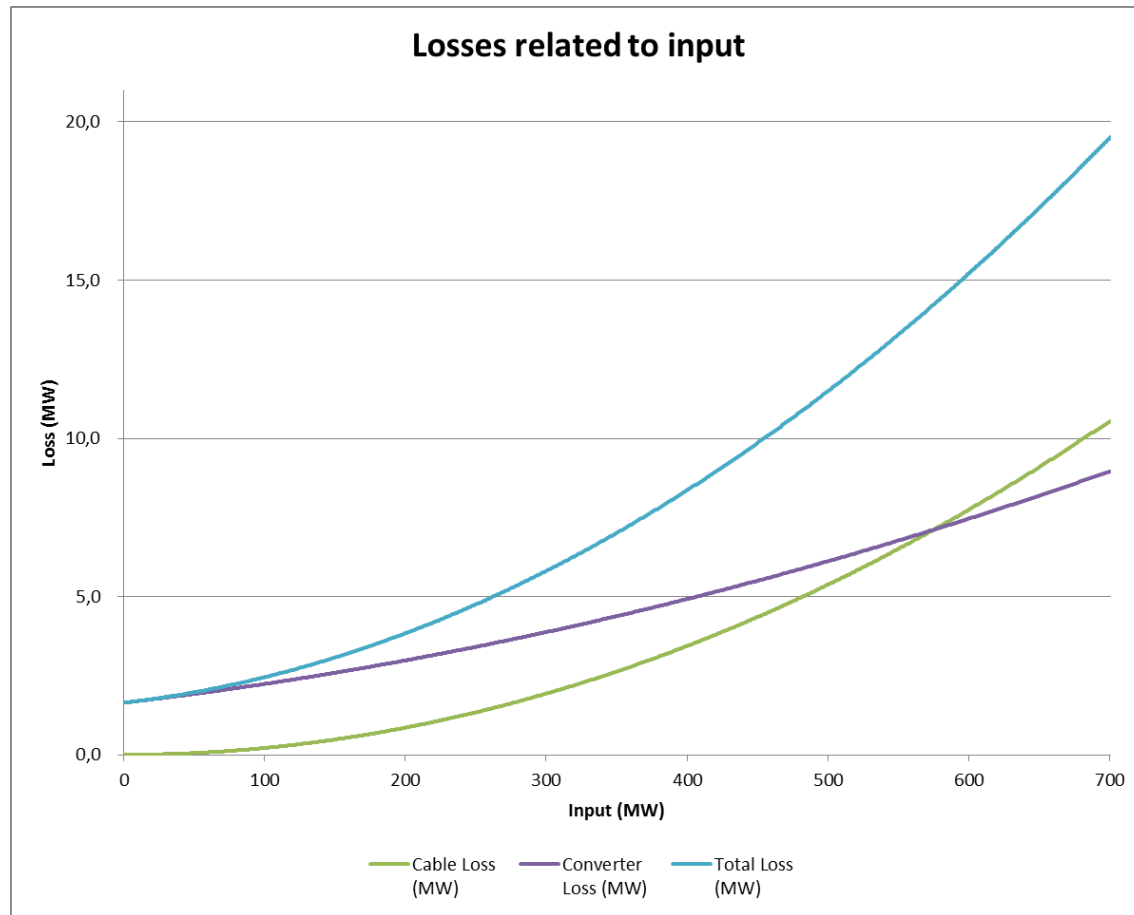

## II. Losses on HVDC-interconnectors (2)

- Implicit Market Losses are a linear approach of the polynomial



## II. Losses on HVDC-interconnectors (3)

- The linear approach of Implicit Market losses only partly covers the actual losses

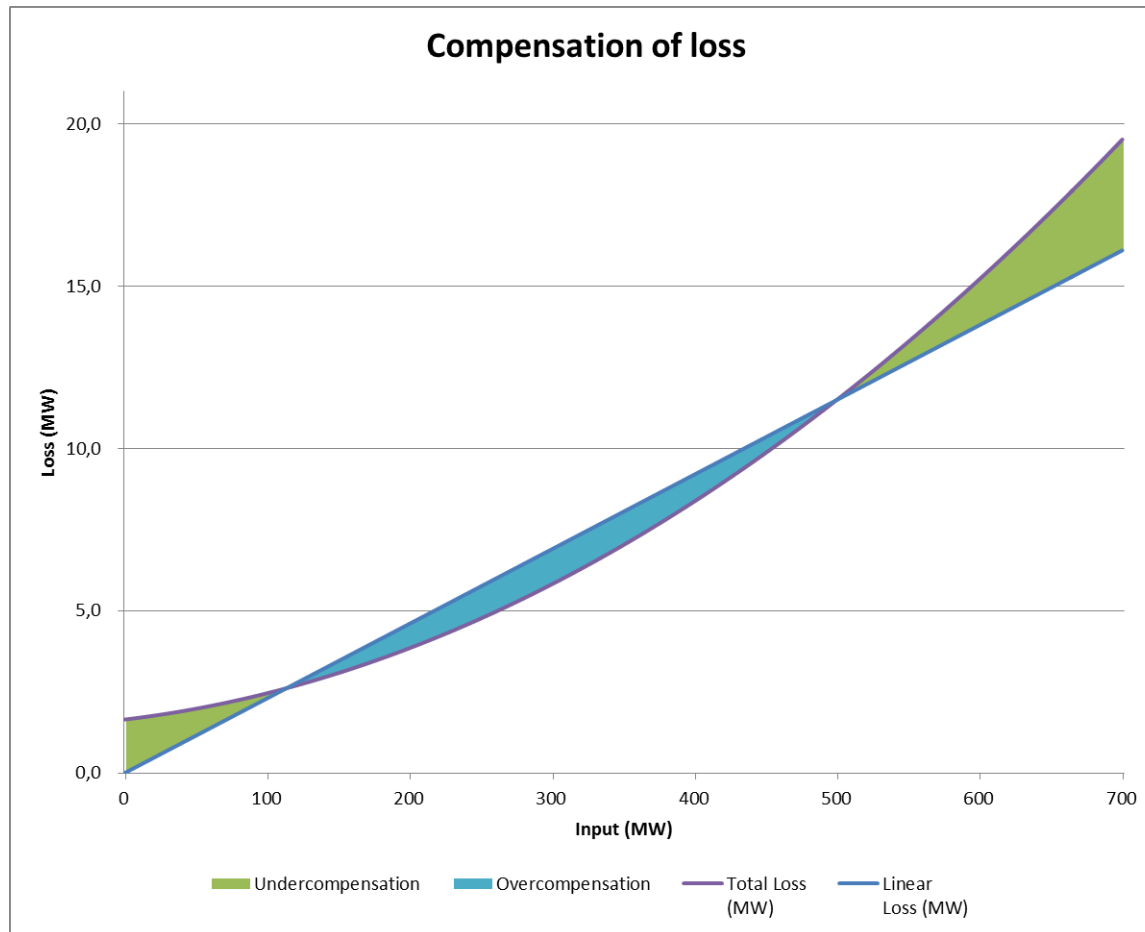

## II. Losses on HVDC-interconnectors (4)

- The Implicit Market Losses create a difference between the allocated capacity at sending end and the allocated capacity at receiving of the interconnector.

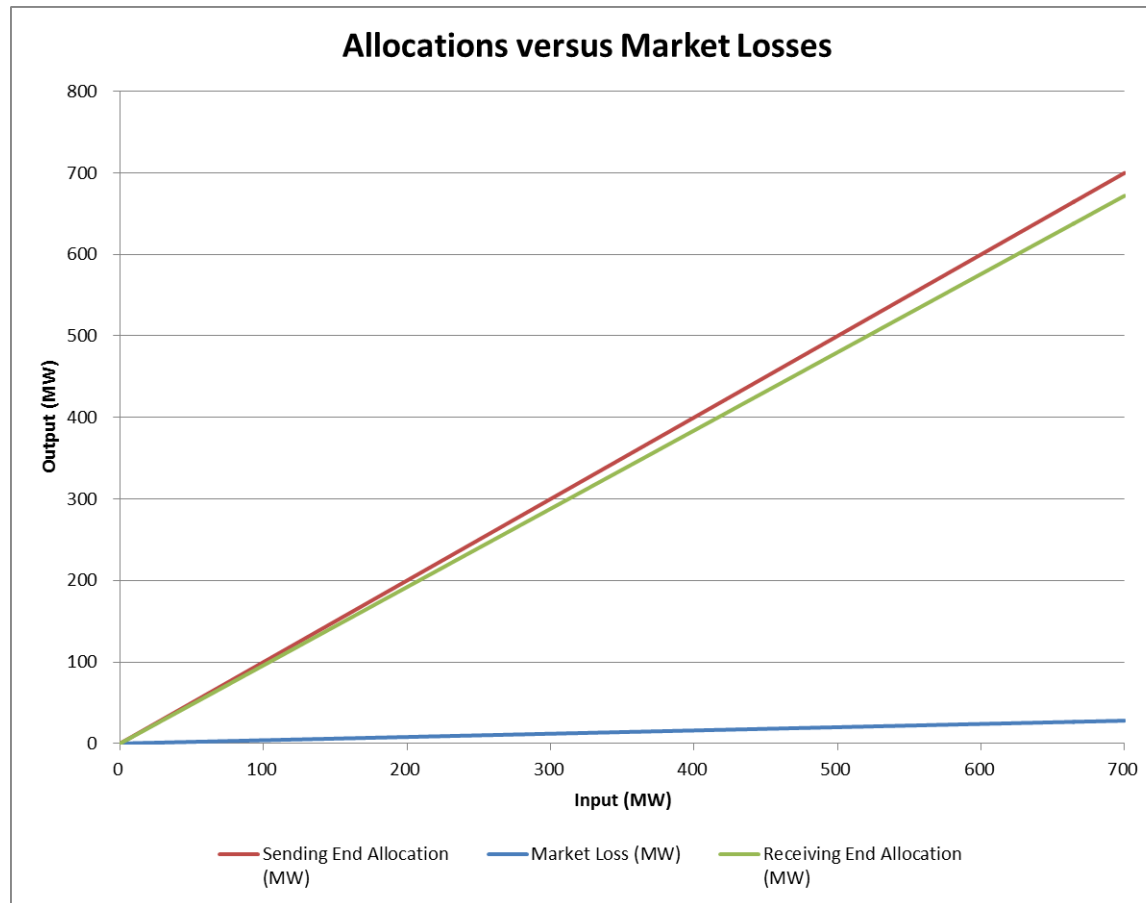

## II. Losses on HVDC-interconnectors (5)

- Several options to handle losses on HVDC-interconnectors:
  - Point of control at receiving end (pulling the energy into an area)
    - Schedule at receiving end must take in account losses, so the market cannot utilize full capacity
    - Losses are to be compensated by the TSO at sending end as far as not taken in account by the market to avoid imbalances in the exporting area.
  - Point of control at sending end (pushing the energy out of an area)
    - Schedule at sending end does not need to consider losses, so the market can utilize full capacity
    - Losses are to be compensated by the TSO at receiving end as far as not taken in account by the market to avoid imbalances in the importing area.
- The costs for losses as far as not taken in account by the market:
  - are on the account of the TSO(s) for commercial interconnectors.
  - are taken into the local tariffs for socialized interconnectors.
- Losses which are taken in account by the market contribute to cost-efficiency.

## **Agenda**

**14:35-15:05**

**I. Introduction**

**II. Losses on HVDC-interconnectors**

**III. Implicit losses in DA Market Coupling**

**IV. Implicit losses in XBID**

**V. BACK-UP: NRAs questions and NEMOs/TSOs answers**

### III. Implicit losses in DA Market Coupling (1)

#### Possibilities by the PCR algorithm

Linear losses are allowed, i.e the losses is a fixed percentage of the flow

#### Deciding the loss factor

Necessary analysis will define the percentage

TSOs specify losses percentage based on actual losses for individual DC line(e.g. IFA ~2%, NorNed~4%)

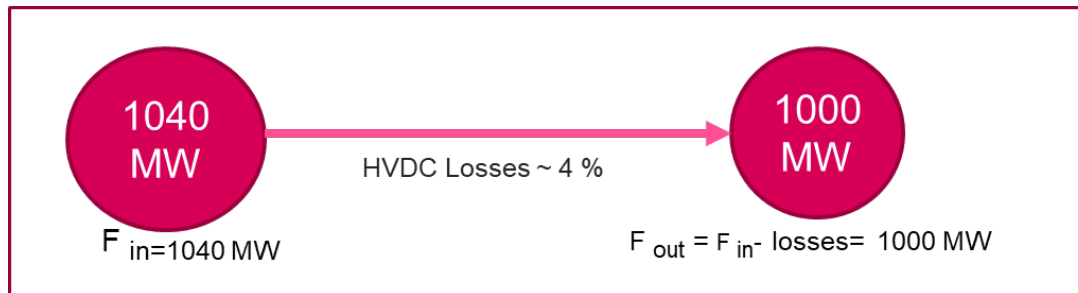

#### Price Properties

$mcp_{to} (1-loss) - mcp_{from} = 0$  when no congestion (no congestion rent),

$mcp_{to} (1-loss) - mcp_{from} > 0$  when line is congested

The price difference will be sufficient to cover the costs of losses when the cable is uncongested

#### Energy Balance

The sum of net positions plus losses is equal to zero



### III. Implicit losses in DA Market Coupling (2)

Interconnector	Loss factor up / down	Capacity* (MW)	Possible energy loss (MWh/h)
NorNed	3,2 %	700	23
Storebælt	1,5 %	600	9
Skagerak	3,6 %	1700	61
Kontek	2,5 %	600	15
Kontiskan	2,6 %	650	17
IFA	2,3 %	2000	46
Estlink	5,1 %	600	31
Fennoskan	2,4 %	1350	32
Baltic	2,4 %	600	14
BritNed	3,0 %	1000	30
SwePol	2,6 %	600	16
Cobra	estimated 2,3%	700	18
NordLink	TBC	1400	TBC
NordBalt	TBC	700	TBC
NSL	TBC	1400	TBC
Nemo Link	2.6% (TBC)	1000	23
ElecLink	Estimated 3%	1000	TBC

\*For some interconnectors the capacity is released at receiving end and for some at sending end.  
 NorNed = 723 MW at sending end or 700 at receiving end  
 BritNed = 1000 MW receiving end

## **Agenda**

**14:35-15:05**

**I. Introduction**

**II. Losses on HVDC-interconnectors**

**III. Implicit losses in DA Market Coupling**

**IV. Implicit losses in XBID**

**V. BACK-UP: NRAs questions and NEMOs/TSOs answers**

## IV. Implicit losses in XBID (1)

- TSOs and NEMOs made the request for offer (RFO) for XBID in 2012
  - Losses was not included as an initial requirement (also other significant functionalities such as shipping module were left out)
- In 2016 TSOs and NEMOs started to work on a solution of how losses could be implemented
  - TSOs and NEMOs have jointly drafted a list of requirements which has been provided to DBAG
  - TSOs, NEMOs and DBAG have jointly been working on the concept.
- Two main models were considered
  1. Trade related losses where a fixed loss factor is applied to each trade regardless of the direction.
  2. Flow related losses where a fixed loss factor is applied for the total netted allocated capacity which implies that actual loss percentage included in each trade may vary.

TSOs and NEMOs agreed on model 2 due to both simplification and that it would be within CACM.

## IV. Implicit losses in XBID (2)

### Loss factor per interconnector:

- The areas in XBID are connected by interconnectors
  - Interconnectors will be configured with a loss factor (percentage).
  - Loss factor is the linear approach of the polynomial
  - Where no losses are taken in account, the loss factor will be 0%.
  - Loss factor different from 0% only to be applied to HVDC-interconnectors.
- On an interconnector where the loss factor differs from 0%:
  - Capacity allocated in all Market Time Frames are to be taken in account.
  - The total capacity allocated at the exporting area (sending end) of an interconnector will be higher than the total capacity allocated at the importing area (receiving end) of an interconnector.
  - After each allocation in XBID the difference between the total capacity allocated at the exporting area (sending end) and the total capacity allocated at the importing area (receiving end) is equal to the loss factor.
- As a consequence:
  - Increasing the flow on an interconnector with losses will increase losses
  - Decreasing the flow on an interconnector will decrease losses.

## IV. Implicit losses in XBID (3)

### Impact on local views:

- Market parties are submitting their order to the NEMO indicating the **Q**uantity (MW) and the **P**rice (€/MWh) and the area where they are located.
- Presentation of a single order in the shared order book will differ across the local views. The order is presented in all local views with the same trade amount ( $Q * P$ ) but quantity and price in the local view are calculated (corrected for losses).
  - The **Q**uantity presented will be lower and the **P**rice presented will be higher when the path which maximizes economic welfare is a lossy path.
  - The **Q**uantity presented will be higher and the **P**rice presented will be lower when the path which maximizes economic welfare is a gainy path.
- *Orders which would lead to switch of the direction of the flow on an interconnector, are presented as two orders, one for the part which reducing existing losses and one for the part creating new losses.*

# IV. Implicit losses in XBID (4)

Example of the Local views on the shared order book

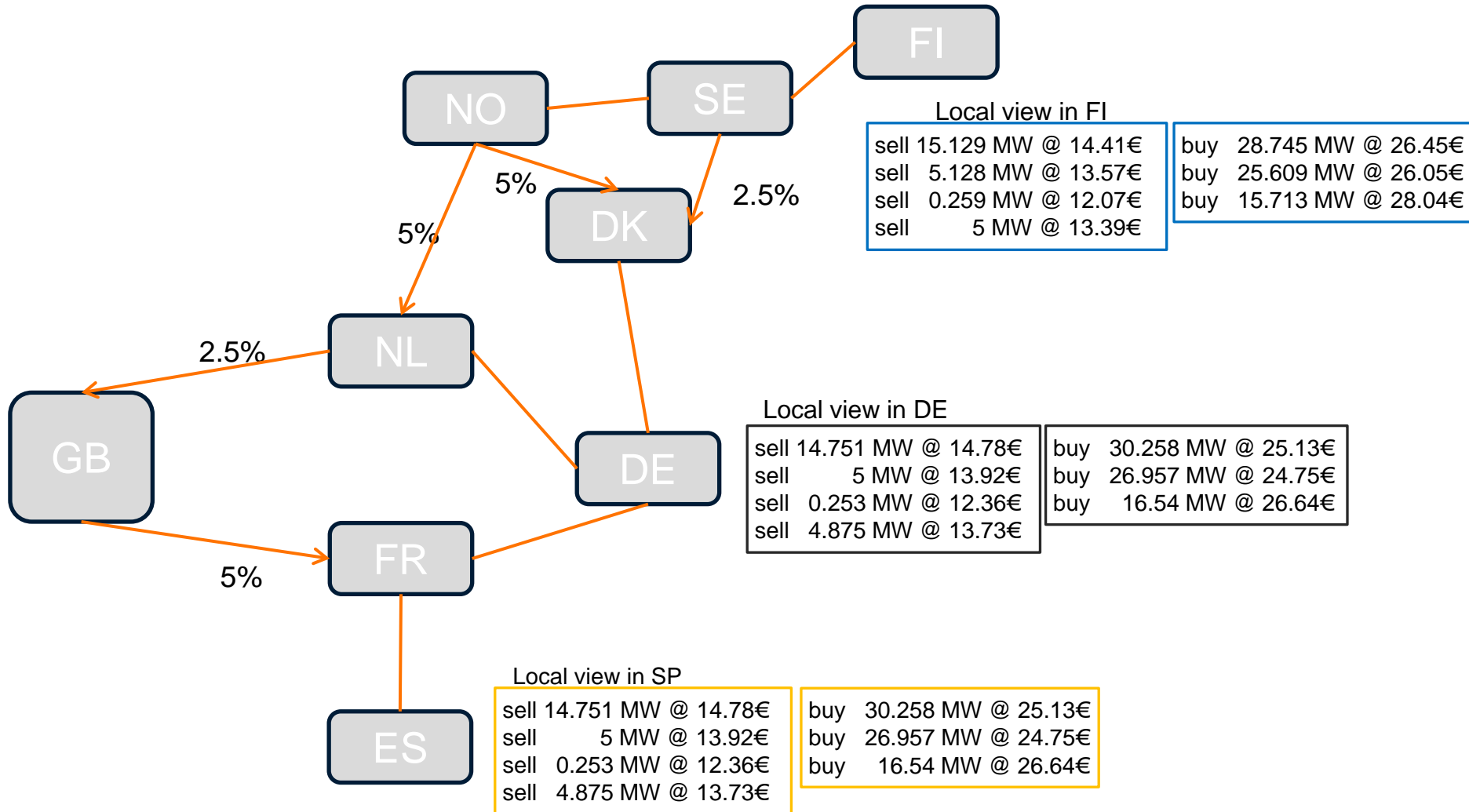

## IV. Implicit losses in XBID (5)

### Losses in the matching:

- Market parties are submitting their order to the NEMO indicating the **Q**uantity (MW) and the **P**rice (€/MWh) and the area where they are located.
- Buy and sell orders which are matched in the Shared Order Book have the same trade amount (**Q** \* **P**).
- Due to the losses, quantities (**Q<sub>S</sub>** and **Q<sub>B</sub>**) will not be the same and the prices (**P<sub>S</sub>** and **P<sub>B</sub>**) will be corrected accordingly to keep the same trade amount (**Q<sub>S</sub> x P<sub>S</sub> = Q<sub>B</sub> x P<sub>B</sub>**).
- Allocations on interconnectors along the path which maximizes economic welfare may differ at both sending end and receiving end. For transfer areas the change of Net Position is zero.
- The path which maximizes economic welfare may contain a combination of lossy parts and gainy parts.
- The path which maximizes economic welfare may contain loops. Endless looping is prevented by the limited cross border capacity and the allocation constraints.

# IV. Implicit losses in XBID (6)

## Example of regular matching, taking additional losses

- Assume the following simple order book
  - Buy order 100MW@50€ in NO2
  - 200MW Receiving end ATC NL->NO2
  - 4% losses
- Assume this NO2 buy order is the best ranked buy in NL
- Assume that a trader in NL hits this buy order
- Then the system creates a sell order against the buy order: this sell order is the copy of the buy order after the "loss filter"
- The trade is made as follows
  - The sell order in NL is executed 104.17MW@48€
  - The buy order in NO2 is executed 100MW@50€
- Cash paid by buyer:  $100 \times 50 = 5000\text{€}$
- Cash received by seller:  $104.17 \times 48 = 5000\text{€}$
- New receiving end capacity:  $200 - 100 = 100$

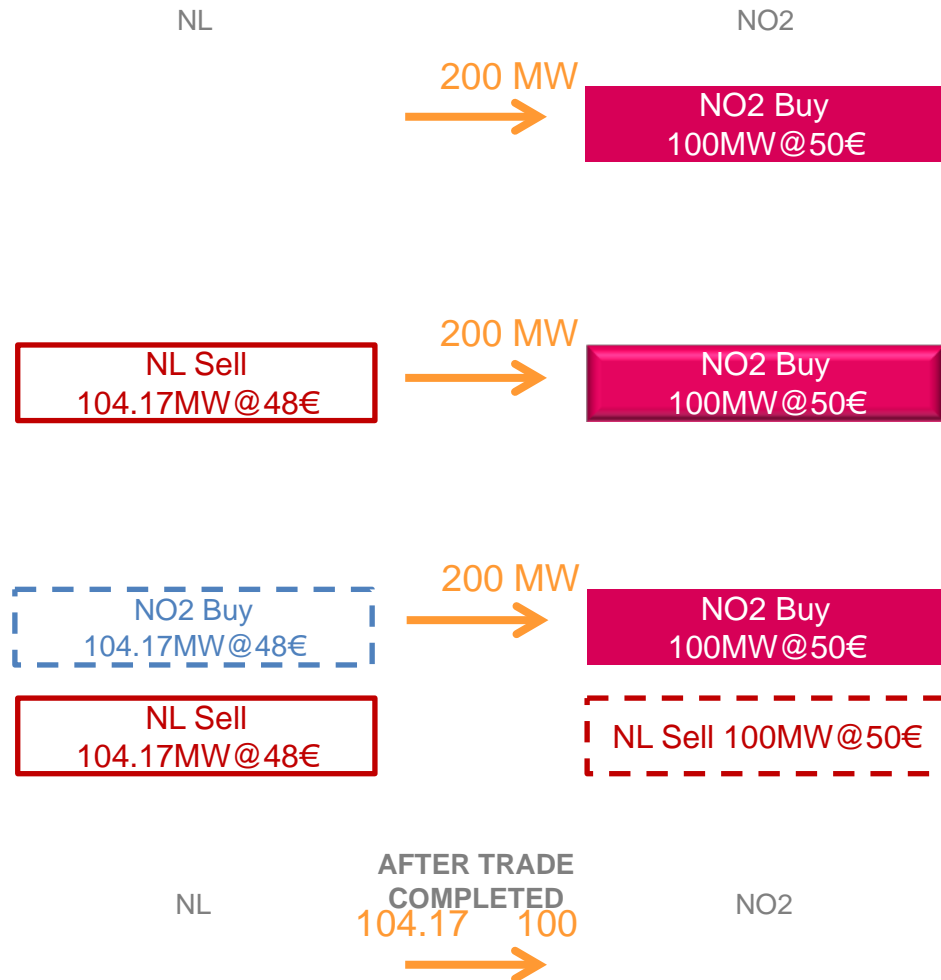



## IV. Implicit losses in XBID (7)

### Example of order matching triggered by release of additional capacity

- Assume the following simple order book
  - Buy order 100MW@50€ in NO2
  - Sell order 80MW@40€ in NL
  - 0MW Receiving end ATC NL->NO2
  - 4% losses
- Assume capacity is now released to the market by the TSO
  - Then the orders can match because the price difference is sufficient to cover losses
- Assume that the buy order has the oldest time-stamp. The trade is made as follows\*
  - The sell order in NL is executed 80MW@48€
  - The buy order in NO2 is (partially) executed 76.8MW@50€
- Cash paid by buyer:  $76.8 \times 50 = 3840\text{€}$
- Cash received by seller:  $80 \times 48 = 3840\text{€}$
- New receiving end capacity:  $200 - 76.8 = 123.2$

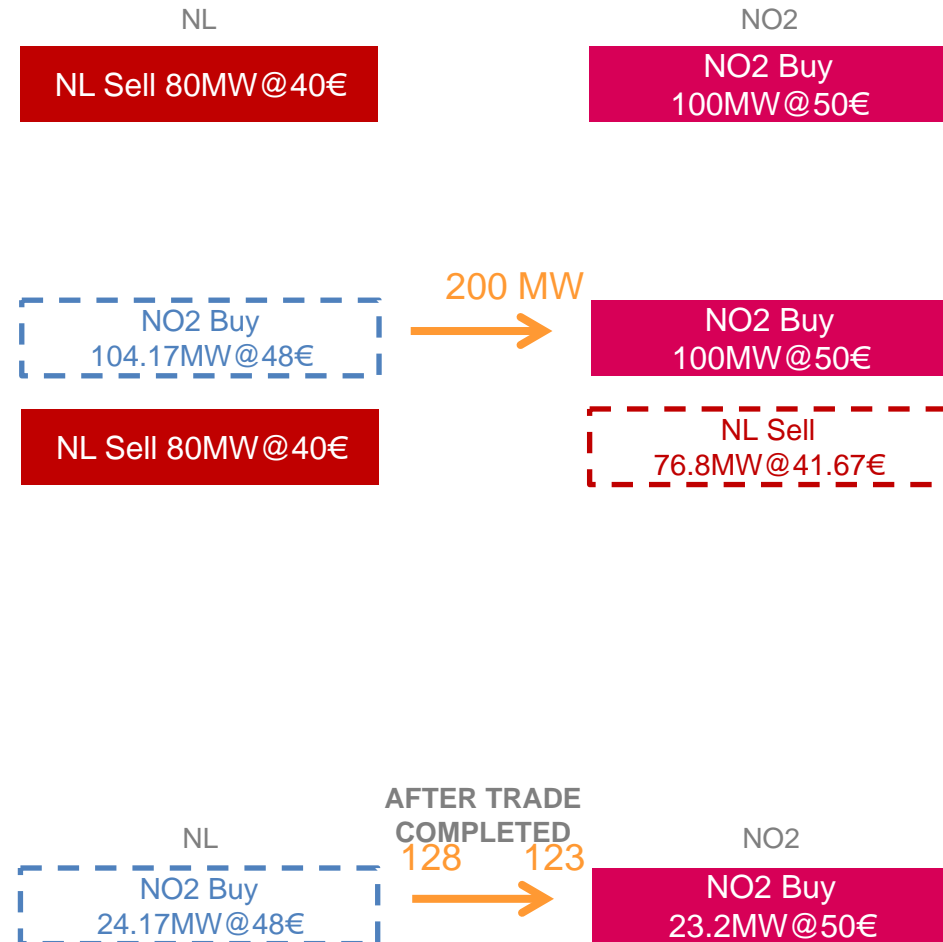

## IV. Implicit losses in XBID (8)

### Single sided trades - Lossy loop:

- Conditions to create a lossy loop resulting in a single sided trade:
  - no buy orders in the Shared Order Book (or orders cannot be reached due to lack of capacity somewhere in the grid)
  - A market party has entered a sell order with a negative price (€/MWh)
  - Sufficient capacity must be available (and reachable) on lossy interconnectors to create a lasso path where the volume of the order is consumed in the grid.
- The algorithm finds a path (in the direction of existing flows) where the sell order is consumed in the grid

### Example:

- Assume a sell order of 10 MW in Norway
- Assume a loop of interconnectors  
Norway – Netherlands – Germany – Denmark – Norway
- Assume 5% losses on interconnectors  
Norway – Netherlands and Denmark – Norway

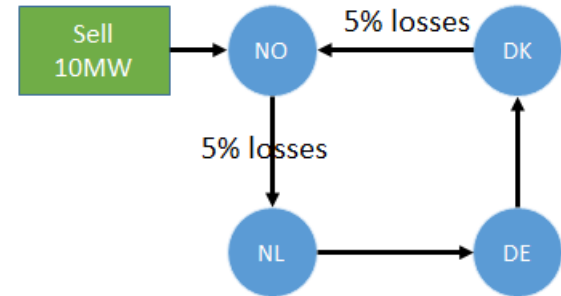

Flows per iteration															
Border: NO-NL				Border: DE-NL				Border: DE-DK				Border: DK-NO			
Loss factor: 5%				Loss factor: 0%				Loss factor: 0%				Loss factor: 5%			
NO		NL		NL		DE		DE		DK		DK		NO	
In	Out	In	Out	In	Out	In	Out	In	Out	In	Out	In	Out	In	Out
	103	97,85			97,85	97,85			97,85	97,85			97,85	92,9575	

- When increasing the flow by 103 MW the sell order can be matched with additional losses

## IV. Implicit losses in XBID (9)

### Single sided trades - Gainy loop:

- Conditions for a gainy loop resulting in a single sided trade :
  - no sell orders in the Shared Order Book (or orders cannot be reached due to lack of capacity somewhere in the grid)
  - A market party has entered a buy order with a positive price (€/MWh).
  - Sufficient capacity must be already been allocated (and reachable) on lossy interconnectors to create a lasso path where the volume of the order is gained from the grid.
- The algorithm finds a path (in opposite direction of existing flows) where the buy order is delivered by the grid

### Example:

- Assume a buy order of 1 MW in Norway
- Assume a loop of interconnectors  
Norway – Netherlands – Germany – Denmark – Norway
- Assume 5% **existing** losses on interconnectors  
Norway – Netherlands and Denmark – Norway

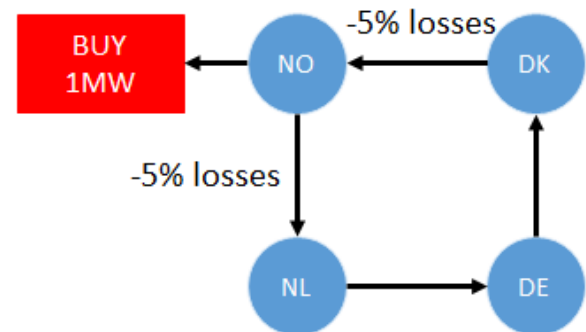

Border:		NO-NL		Border:		DE-NL		Border:		DE-DK		Border:		DK-NO	
Loss factor:		5%		Loss factor:		0%		Loss factor:		0%		Loss factor:		5%	
NO		NL		NL		DE		DE		DK		DK		NO	
In	Out	In	Out	In	Out	In	Out	In	Out	In	Out	In	Out	In	Out
	9,256	9,743			9,743	9,743			9,743	9,743			9,743	10,256	

When reducing the flow by 10 MW the requested buy order can be matched with reduced losses

## Questions



## **Agenda**

**14:35-15:05**

**I. Introduction**

**II. Losses on HVDC-interconnectors**

**III. Implicit losses in DA Market Coupling**

**IV. Implicit losses in XBID**

**V. BACK-UP: NRAs questions and NEMOs/TSOs answers**

## V. NRAs questions and NEMOs/TSOs answers (1)

- What are the target function(s) and constraints related to this solution?

In accordance with the CACM regulations, the objective function is maximizing economic welfare under given constraints. The constraints to the model are

- available capacity and loss factors relating in and out flows on interconnectors,
- order quantity execution ranges,
- flow balance conditions per delivery area and period, and
- a cash value condition relating execution prices at the in and out ends of interconnectors.

The unavoidable consequence of adding the losses constraint is that cycles have to be included to secure the maximum economic welfare. In addition, the model

- automatically minimizes the overall losses (by netting) so as not to unnecessarily waste power, and
- guarantees that the local (views) order books are not crossed, thus there are no misleading price signals.

## V. NRAs questions and NEMOs/TSOs answers (2)

- Will there be price difference between areas (bidding zones) even in the absence of congestion?  
Just like in day ahead auctions, losses will result in price differences between bidding zones even in the absence of congestion and lack of alternative paths without losses. This is not a specific characteristic of this solution but of implementing losses in a market based solution in general. In case pre-existing losses are reverted the price difference would be negative.
- How does the matching (of single sided trades) against the 'grid interconnector' work from a trading perspective? How would the money flows look like?  
Single sided trade is always executed with zero price, so there is no financial flow.
- Will the solution mix genuine XBID orders and losses mitigation?  
Yes, those will be in same Shared Order Book. In trading screens the virtual loop orders will be displayed mixed with genuine XBID orders in a price ranking order.
- E.g.: What happens if the flow goes 1000 MW A>B from an exchange in DA and 1000 MW B>A in ID. No losses would have occurred in reality. Will the system take this into account?  
Yes, the model differentiates between already existing flows (whatever is allocated from whatever relevant part on the interconnector) and the so-called shift (i.e. that particular part of flow that we are dealing with in the moment of calculation). Rules for parallel and antiparallel netting respecting the losses are then applied.
- Does the losses solution only include single sided trades or are they just a little part of it?  
Single sided trades are just a part of the solution. Market conditions will determine how significant part the single sided trades are. Due to rare circumstances required for single sided trades we do not expect single sided trades to occur very often.

## V. NRAs questions and NEMOs/TSOs answers (3)

- Who decides on DC lines 'getting' losses? It does not make any sense since any line (also AC) has losses and trading from Finland to Portugal over AC will have far greater losses than a simple trade over NorNed.

NRA approval is required for TSOs to expose losses to market parties on a DC line. In the single day-ahead coupling losses are already exposed to market parties for a range of DC links and market parties should in general face the same conditions in the single intraday coupling. For DC links where losses are exposed to market parties in the single day-ahead coupling and losses are not exposed to market parties in the single intraday coupling there is basically no equal treatment of market parties.

- What about the physical reality? Losses on DC already are accounted for in DA (and LT?). Does the solution prevent double-counting?

DA uses losses for DC interconnectors where it has been defined. XBID gets the DA final flows for interconnectors and will use the information on calculations. There is no double-counting. The solution ensures that a fixed percentage of loss of the final flow is exposed to market participants, irrespective whether intraday trading increases flows, decreases flows or even changes the flow direction.

- How is the direction of the flow determined at all times? E.g.: How is it defined at the beginning of ID trading? How is it updated?

Initial interconnector capacities (NTC & AAC) are provided by TSOs on daily basis based on DA results. During the intraday trading the system keeps itself up-to-date. The scheduled flow/exchanges are calculated / updated based on agreed model for routing of each trade



## **Agenda**

**15:20 – 15:35**

- 1. Welcome, agenda**
- 2. Feedback Market Parties on XBID operation**
- 3. Improvements of XBID Solution**
- 4. Regulatory changes and foreseen impact on XBID**
- 5. Project status update – Mark Pickles**
- 6. 2<sup>nd</sup> wave LIPs and high level planning**
- 7. Wrap up**

## 5. Project status update

### Activity since Go-Live

- Scoping, testing and deployment of Release 1.5
  - Entered into production on 30<sup>th</sup> October
  - This release implemented: Software Corrections; Third party software upgrades; An upgrade of the AlarmTILT software (automated notifications); A change to the RabbitMQ cluster setup; and Introduction of a dedicated mail server for XBID Production
- Introduction of the Austrian/German Bidding Zone Split in XBID
- Resettlement of historical and quarterly costs across all parties (IDOA signatories)
- Undertaking performance testing on a range of scenarios
- Testing in advance of the Long Clock change (no issues were experienced on 28<sup>th</sup> October)
- Evaluating aspects such as Tick Size and Orderbook depth
- Scoping Release 2.0
- Agreeing 2019 budget and roadmap through to 2021

## 5. Project status update

### Scope of Release 2.0

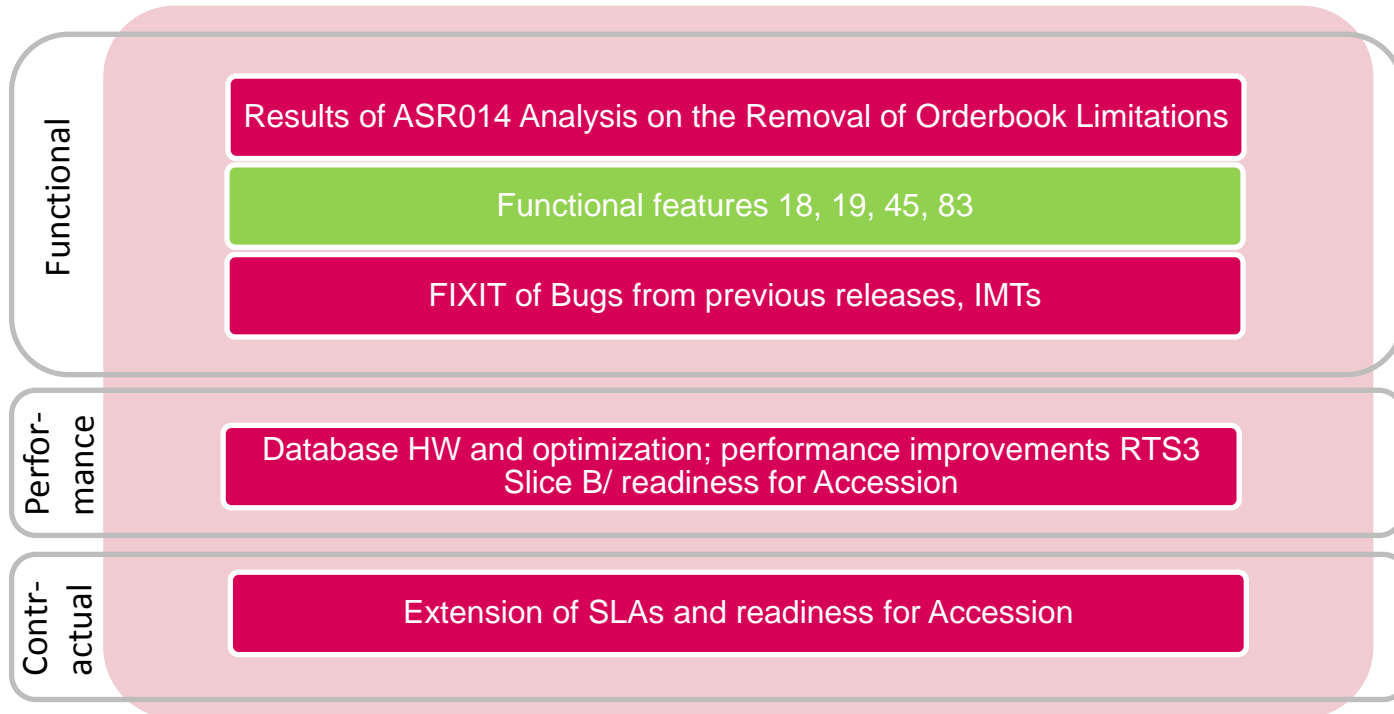

# 5. Project status update High Level Plan

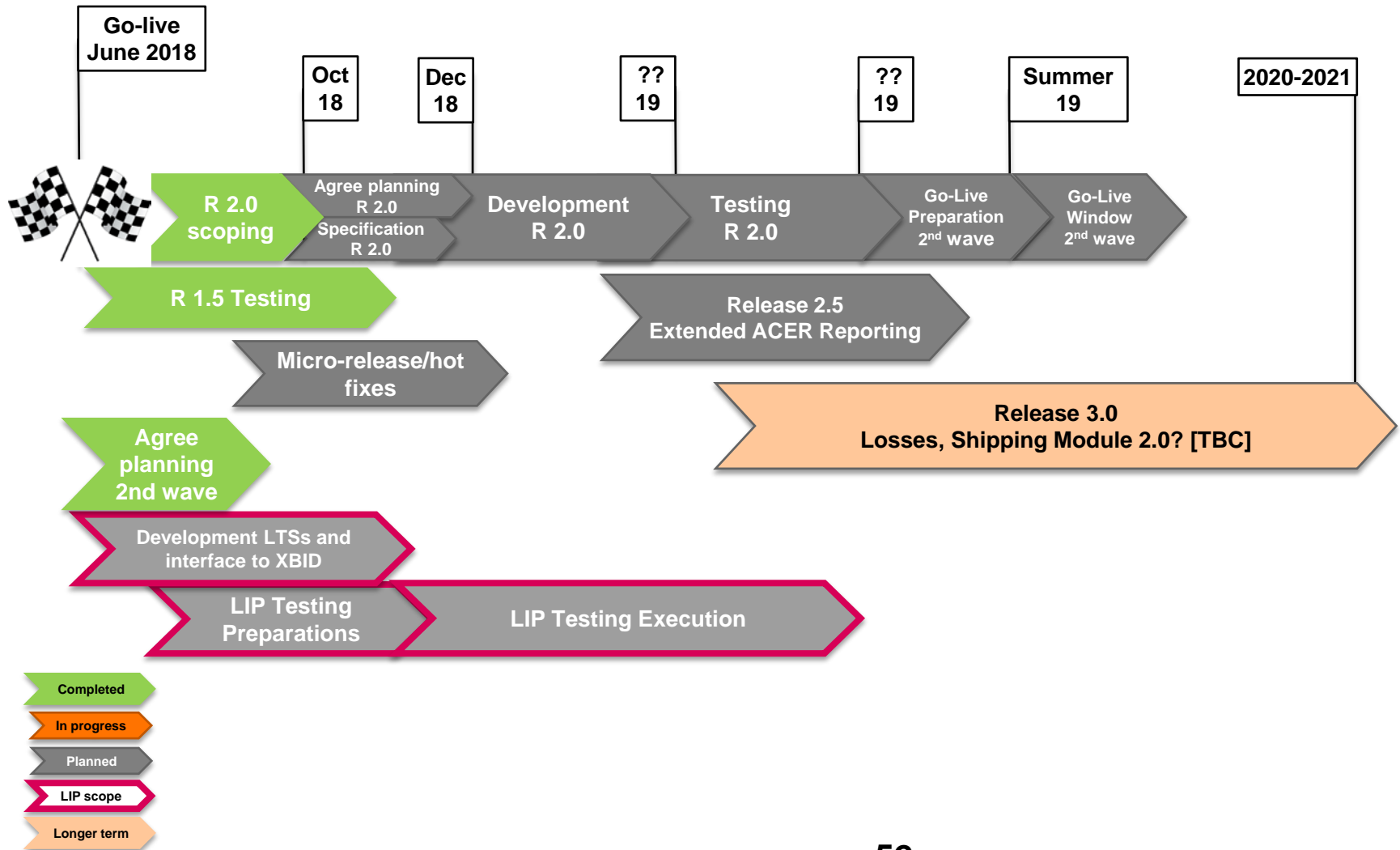

## **Agenda**

**15:35 – 15:50**

- 1. Welcome, agenda**
- 2. Feedback Market Parties on XBID operation**
- 3. Improvements of XBID Solution**
- 4. Regulatory changes and foreseen impact on XBID**
- 5. Project status update**
- 6. 2<sup>nd</sup> wave LIPs and high level planning – Zuzana Vackova**
- 7. Wrap up**

# 6. 2<sup>nd</sup> wave LIPs and high level planning

## Overview 2<sup>nd</sup> wave LIPs and parties involved

LIP		Participants
15	AT-CZ, AT-SI, AT-HU, BG-RO, CZ-DE, CZ-PL, DE-PL, HR-SI, HR-HU, HU-RO	<b>NEMOs:</b> BSP, Cropex, EPEX, HUPX, IBEX, Nord Pool, OPCOM, OTE <b>TSOs:</b> 50Hertz, APG, CEPS, ELES, ESO, HOPS, MAVIR, PSE, Transelectrica, TTG
16	LT-PL, PL-SE	<b>NEMOs:</b> EPEX, Nord Pool, TGE <b>TSOs:</b> Litgrid, PSE, Svk

- Operational
- Operational, part of 2nd wave
- 2nd wave

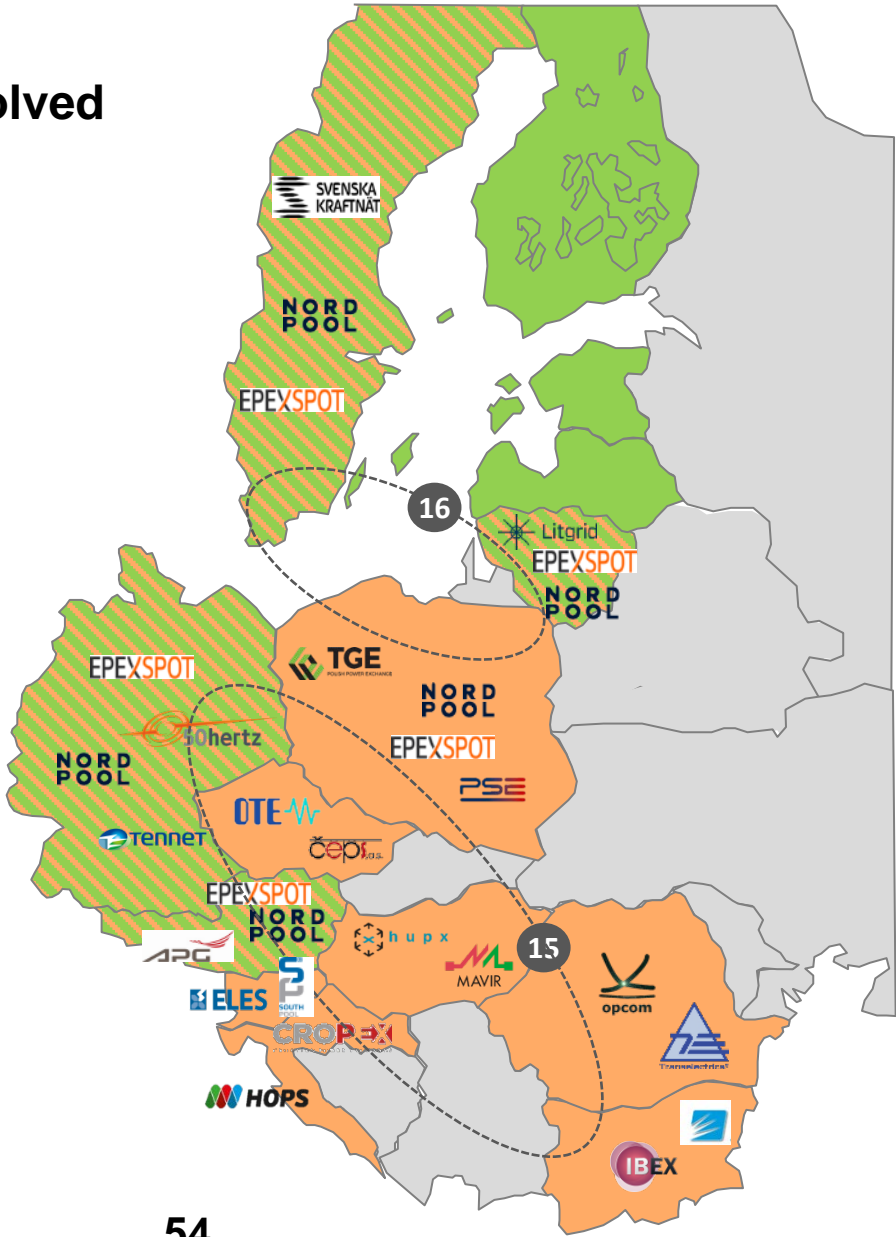

## Objectives of the 2nd wave

- So far XBID platform has been stable and reliable tool for traders
- Trading participation as well as trading values are constantly increasing on XBID platform
- **General aim of the 2nd wave is to:**
  - further integrate Member States in order to achieve single integrated intra-day market
  - increase liquidity of ID volumes in single markets
  - improve ID trading opportunities across Europe
- “Establish a common cross border implicit continuous Intraday trading solution across Europe, where all the cross border capacities are allocated...” *Quote from Request for Offer (RFO)*





## 6. 2<sup>nd</sup> wave LIPs and high level planning Overview of LIP 15

### Geographical scope

- Austria, Bulgaria, Croatia, Czech Republic, Germany, Hungary, Poland\*, Romania, Slovenia
  - 9 bidding zones
  - 10 borders

### Involved parties (TSO/PXs) in the project

#### NEMOs



#### TSOs



### Foreseen type of allocation

- Implicit
- Implicit & Explicit for HR-SI border





## 6. 2<sup>nd</sup> wave LIPs and high level planning Overview of LIP 16

### Geographical scope

- Lithuania, Poland, Sweden
  - 3 bidding zones
  - 2 borders

### Involved parties (TSO/PXs) in the project

#### NEMOs



#### TSOs



### Foreseen type of allocation

- Implicit

## 6. 2<sup>nd</sup> wave LIPs and high level planning

### Project setup

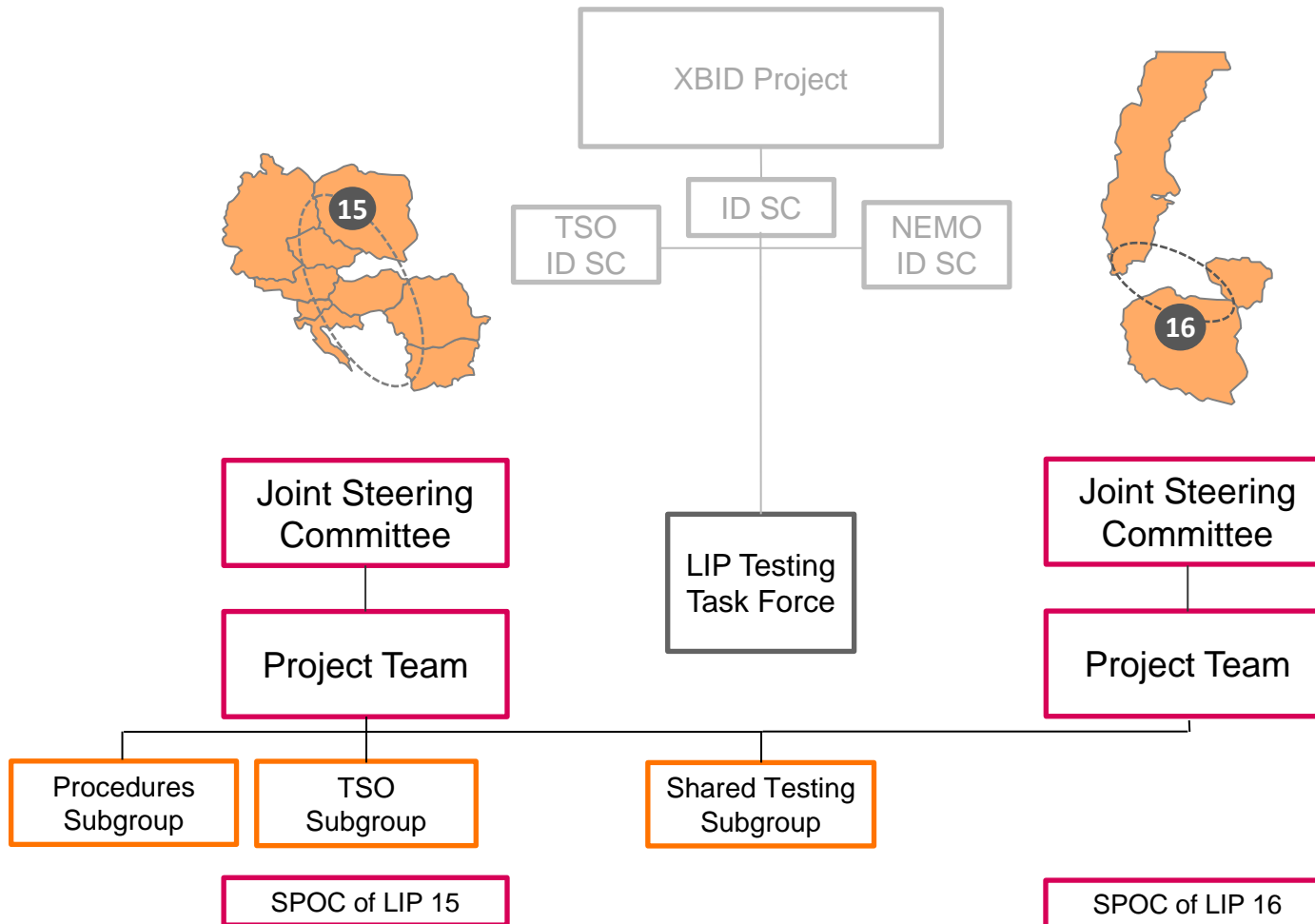

## 6. 2<sup>nd</sup> wave LIPs and high level planning

### LIP Testing Planning (*tentative and not a defined outcome*)

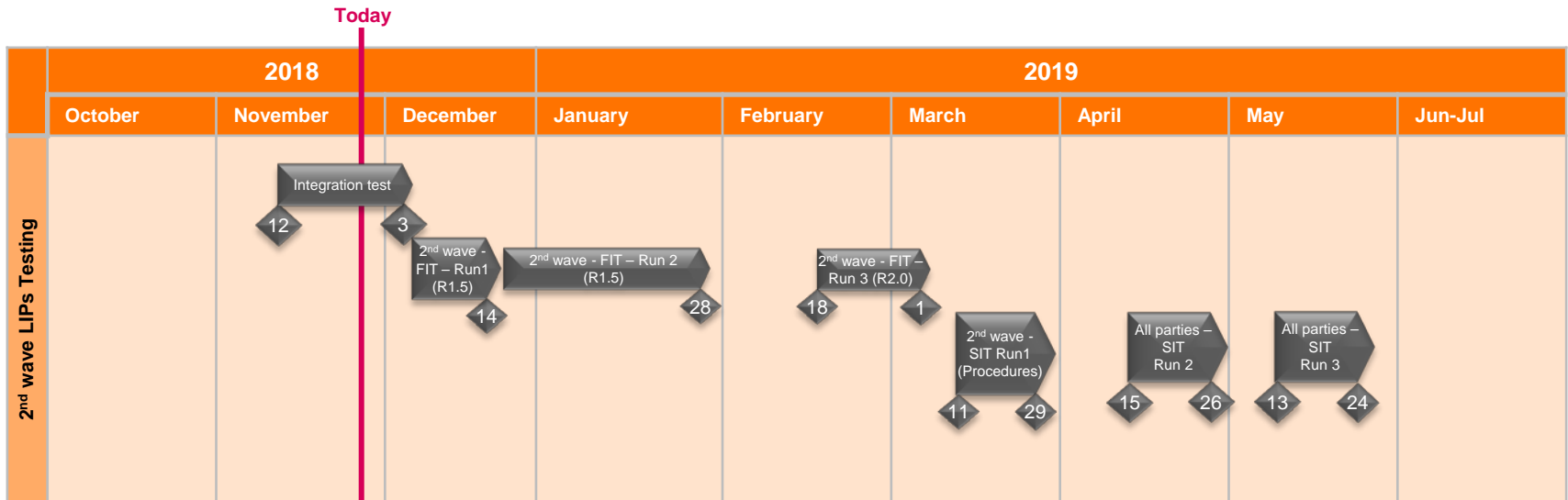

So far all Parties of the LIP 15 and LIP 16 are tentatively confident to go-live and be connected to the XBID platform by the Q3 of the 2019 latest.

\* TGE is in the process of development of its LTS system and plans to join the LIP Parties in XBID R 2.0 tests in February 2019 to meet the deadline

**Thank you  
for your attention**

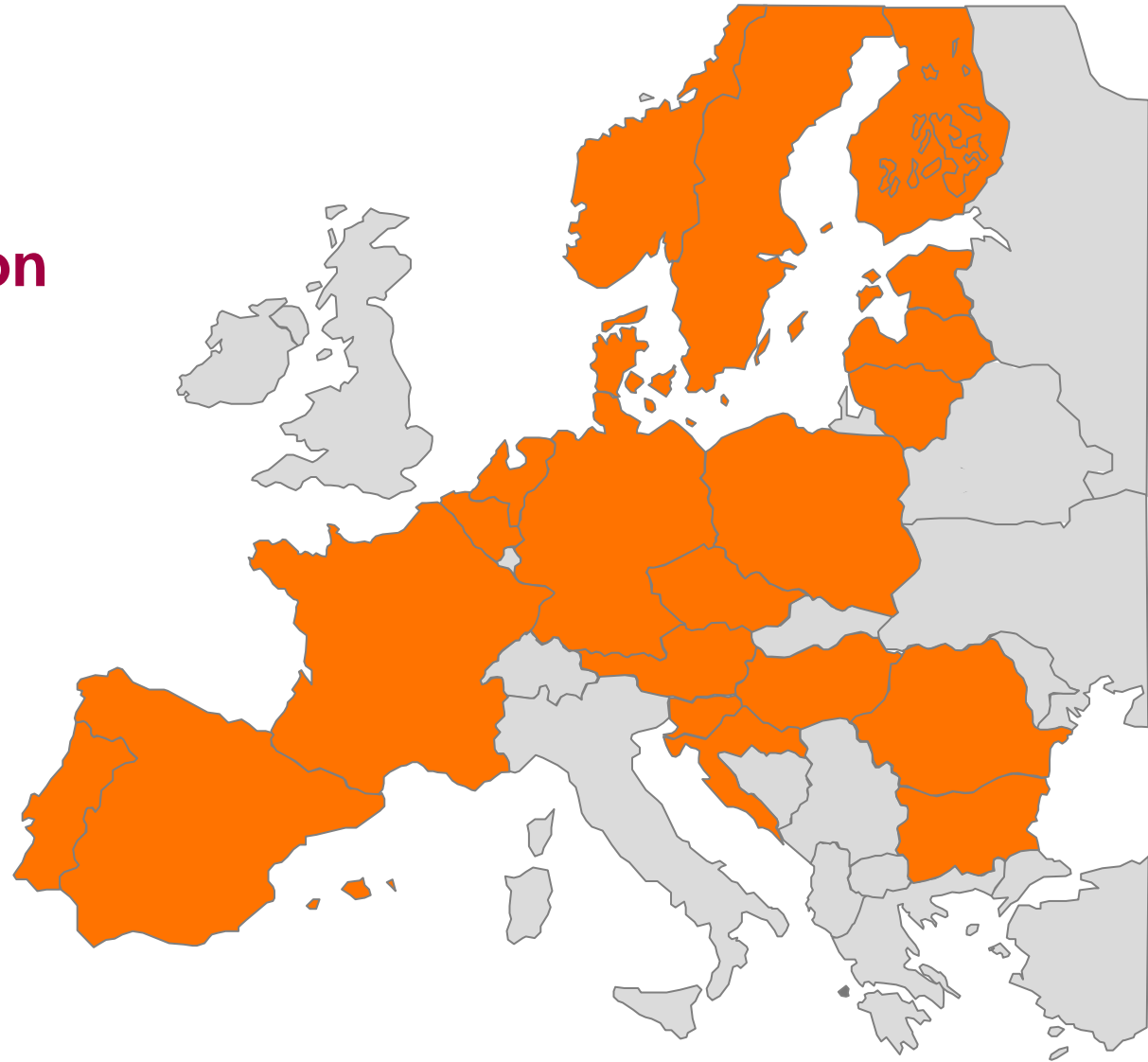

\* Countries in operation after the 2<sup>nd</sup> go-live (tentative)

## **Agenda**

**15:50 – 16:00**

- 1. Welcome, agenda**
- 2. Feedback Market Parties on XBID operation**
- 3. Improvements of XBID Solution**
- 4. Regulatory changes and foreseen impact on XBID**
- 5. Project status update**
- 6. 2<sup>nd</sup> wave LIPs and high level planning**
- 7. Wrap up – Mark Pickles**

**Thank you very much for your attention!**

**A safe journey home...**